

MaxMotion

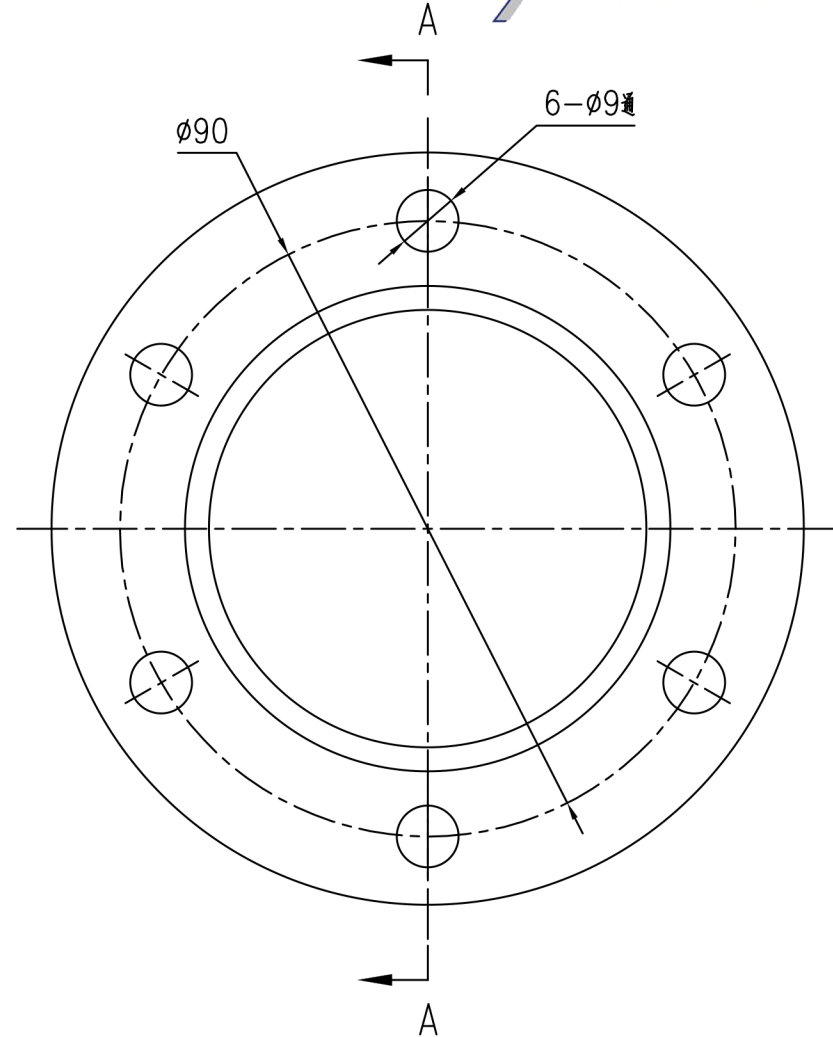
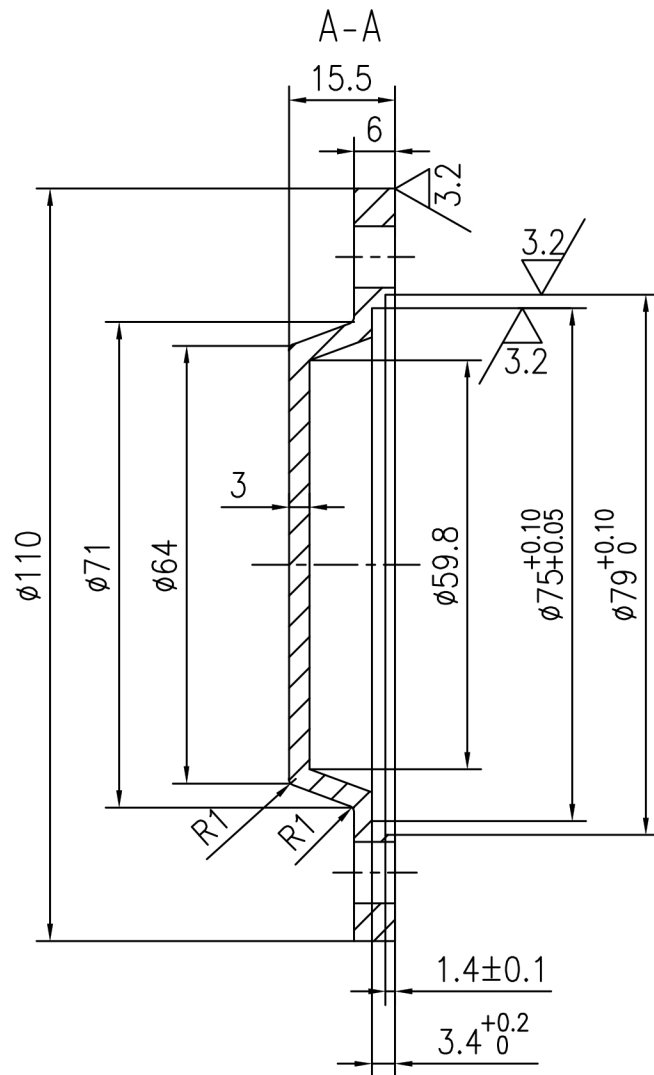

1. The cover should incorporate an "O" ring to prevent water.
2. The part need to be included six outer hexagon bolt.

MRS63 COVER